

ЛЕНА

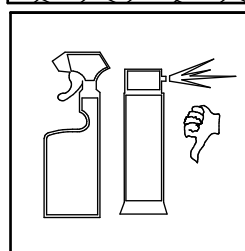

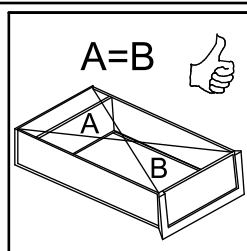

2x K16 a43	6x K0 a44	8x b19	3x L 340 mm c520	12x φ5x17 mm d1	8x φ5x17 mm d3
26x φ7x50 mm e1	2x φ6,3x13 mm e2	4x φ5x11 mm e4	28x φ8x30 mm f1	2x g2	9x 56x56/20 mm k52
110x l1	7x 3 mm l3	1x m48	2x n2	2x 50x12\1,5 mm n3	2x n10
1x 81x21x15\1,5mm n14	2x n122\1	4x silikon φ8x1,8mm o21	2x o43\1	1x o43\6	
4x φ3,5x13 mm p1	6x φ3,5x13 mm p5	9x φ4x30 mm p9	22x φ4x30 mm p21	16x φ3,5x15 mm p51	7x φ3x16 mm p52
4x φ3x10 mm p400	14x φ15x12mm #16 r1	14x 20/11 r42	4x s1	12x ø16 s2	1x z1

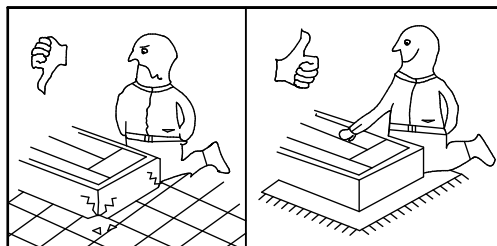
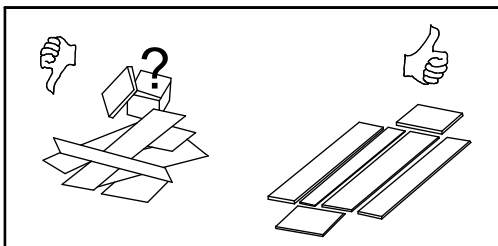
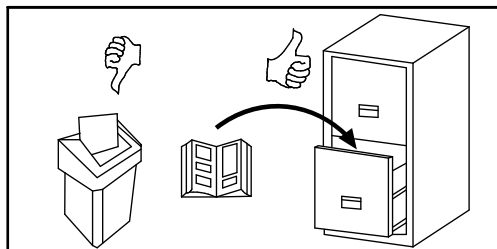
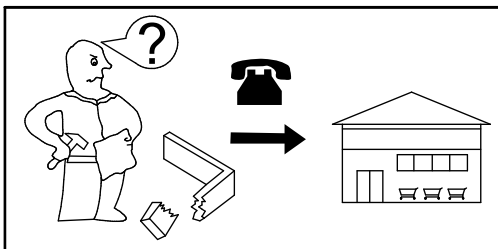
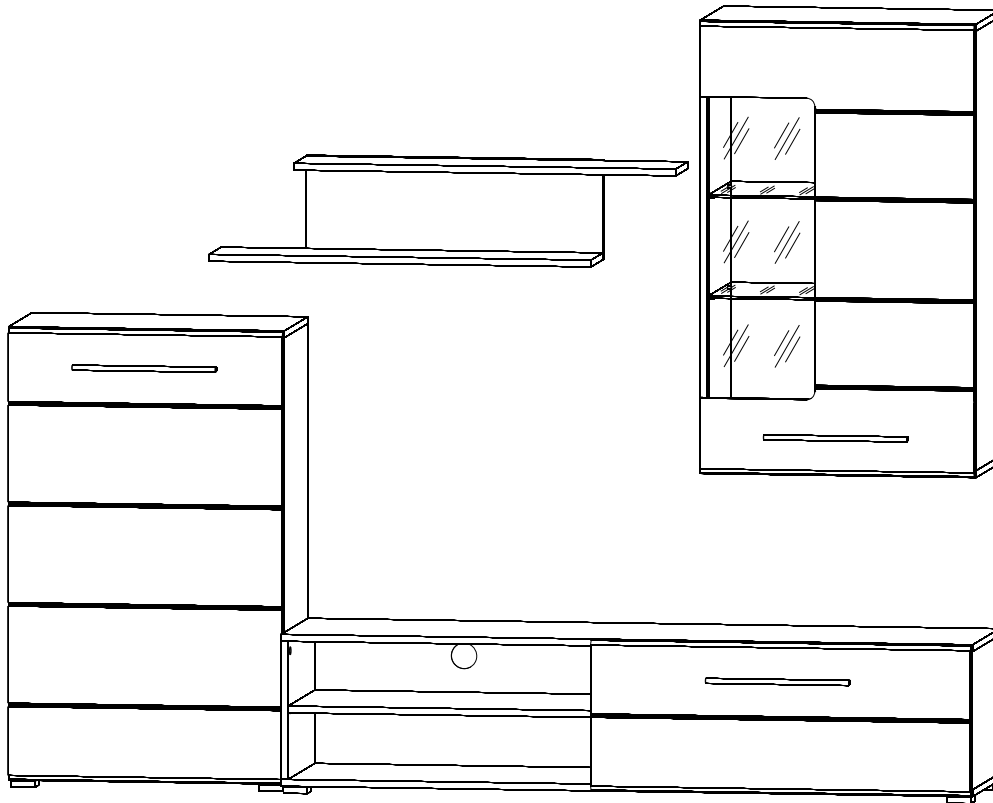
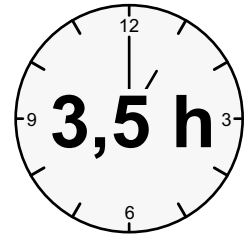
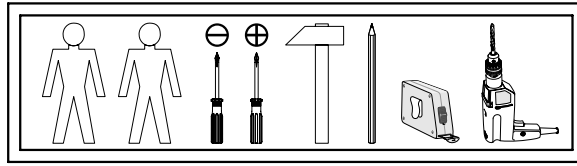
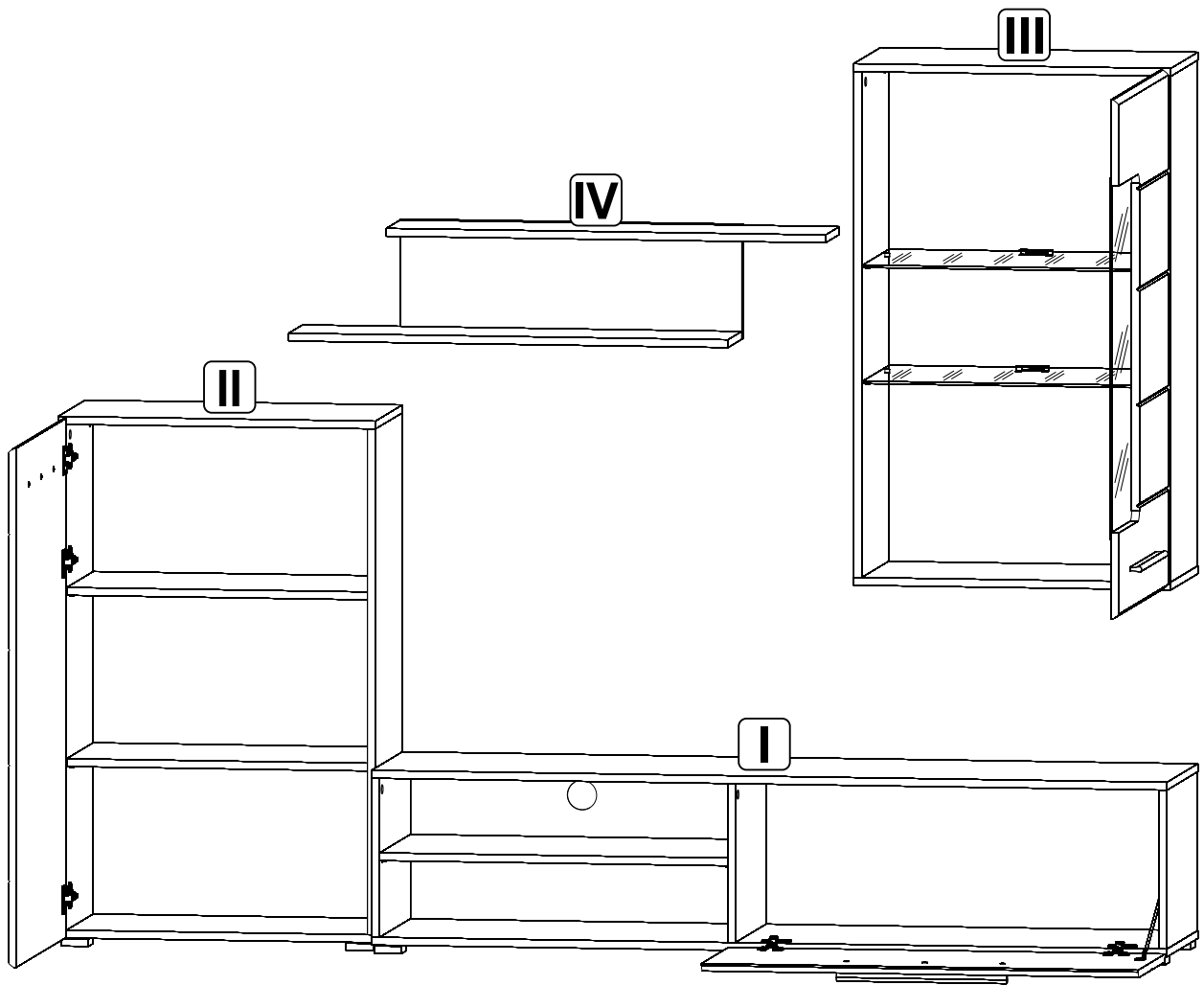
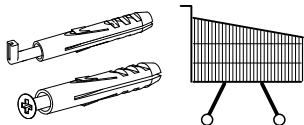

I Тумба РТВ

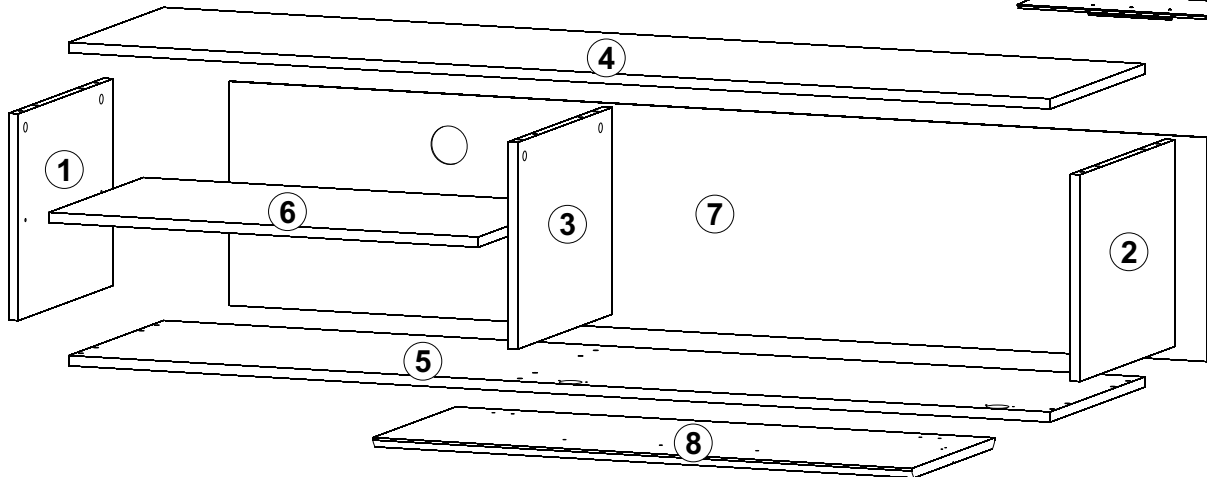
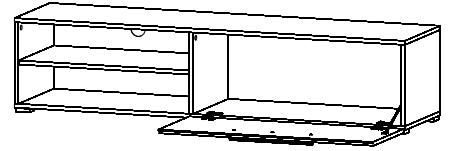

A	B	C	D	A	B	C	D		
1	ML1-105	323	400	1/3	5	ML1-205	1630	400	1/3
2	ML1-106	323	400	1/3	6	ML1-302	713	398	1/3
3	ML1-107	323	400	1/3	7	ML1-903	1624	350	1/3
4	ML1-204	1630	400	1/3	8	ML1-002-01	895	350	3/3



1 §2

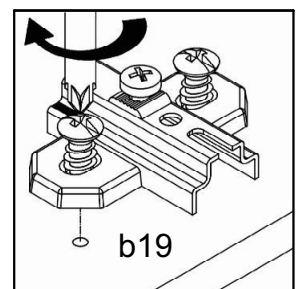
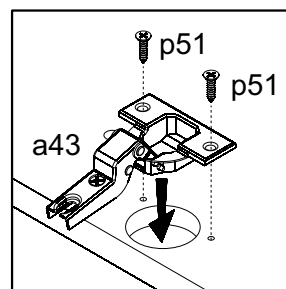
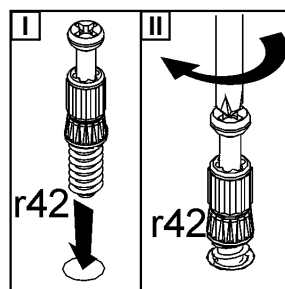
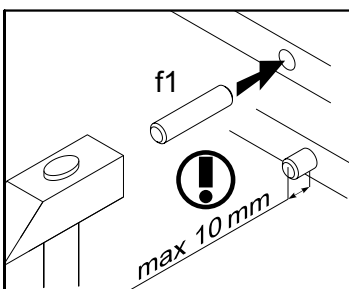
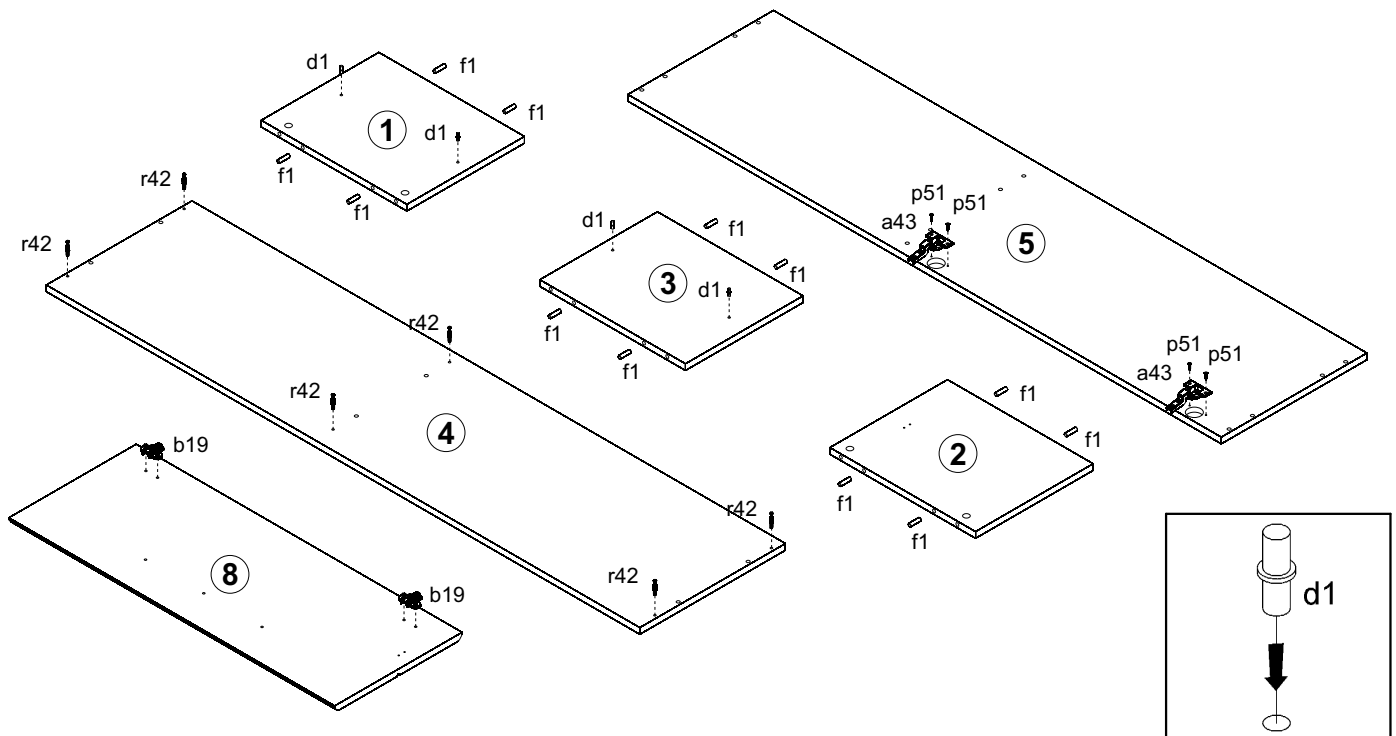
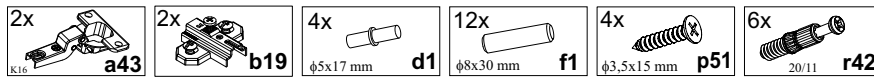

2

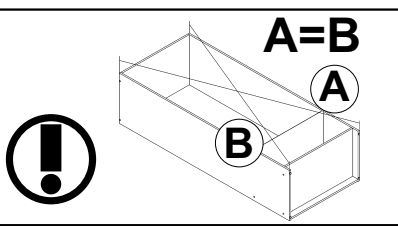
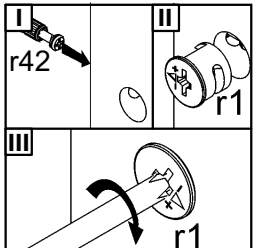
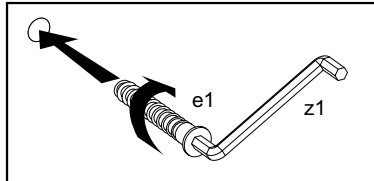
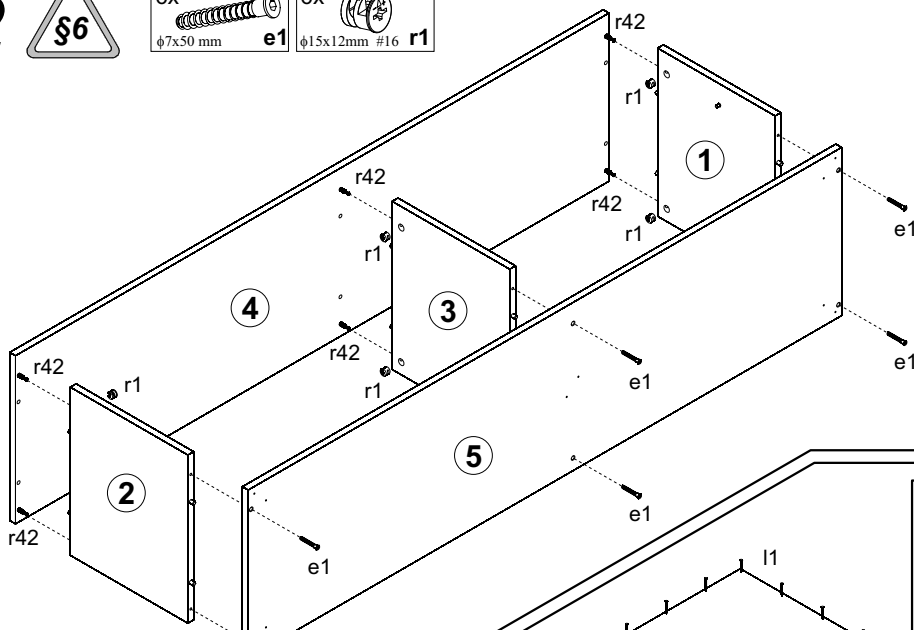
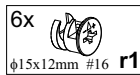
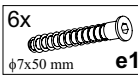

3

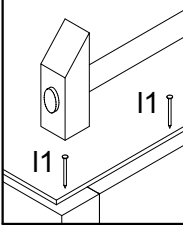
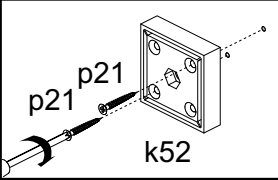
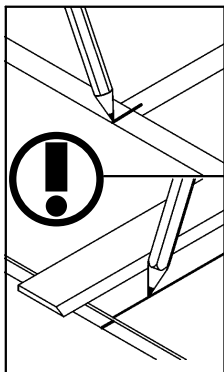
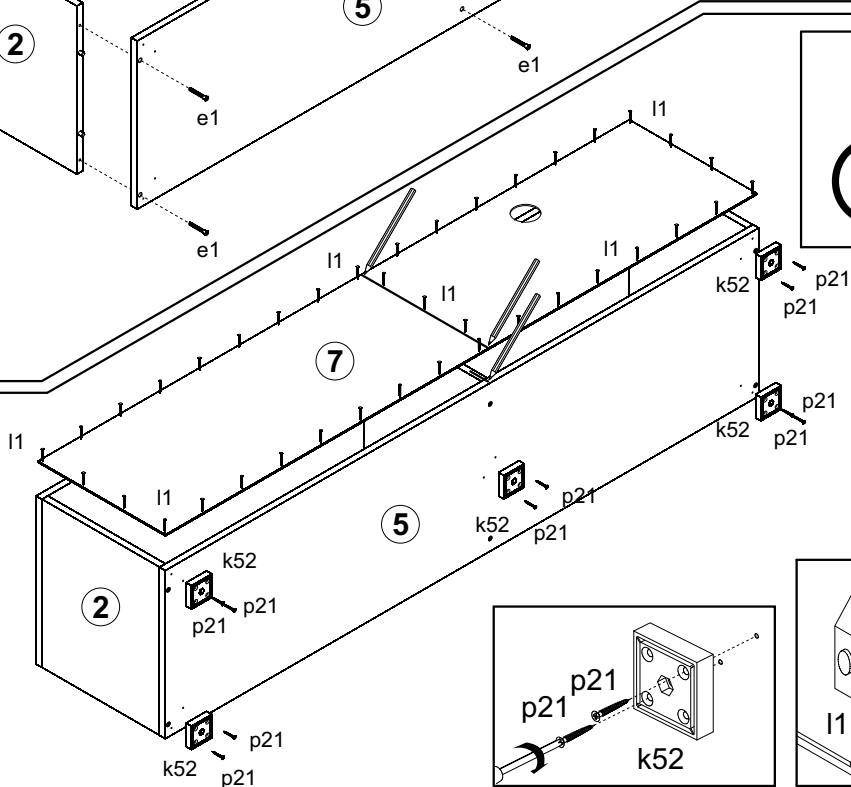
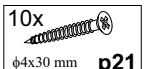
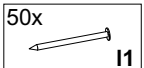
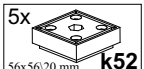

4

